

BIDS AND AWARDS COMMITTEE

Section I. Invitation to Re-Bid

Supply of Labor and Materials for the Construction of Garbage Container and Storage Area for Hazardous Material

The Philippine International Convention Center, through the 2017 Approved Budget intends to apply the sum of Three Million Forty-Four Thousand Nine Hundred Eighty-Eight Pesos and Twenty-Nine Centavos (P3,044,988.29), VAT Inclusive, being the total Approved Budget for the Contract (ABC) of the aforesaid requirement. Bids received in excess of the ABC shall be automatically rejected at bid opening.

The PICC now invites bids for procurement of the abovementioned requirement. Completion of the Works is within Sixty (60) Calendar Days. Bidders should have completed, within the last three (3) years from the date of submission and receipt of bids, a contract similar to the project, whose value must be at least fifty percent (50%) of the ABC. The description of an eligible bidder is contained in the Bidding Documents, particularly, in Section II. Instruction to Bidders.

Bidding will be conducted through open competitive bidding procedures, using non-discretionary "pass/fail" criterion as specified in the 2016 Revised Implementing Rules and Regulations (IRR) of Republic Act 9184 (RA 9184), otherwise known as the "Government Procurement Reform Act."

Bidding is restricted to Filipino citizens/sole proprietorships, cooperatives, and partnerships or organizations with at least seventy-five percent (75%) interest or outstanding capital stock belonging to citizens of the Philippines.

Interested bidders may obtain further information from PICC-BAC and inspect the Bidding Documents at the address given below from 8:00 am to 5:00 pm.

A complete set of Bid Documents may be acquired by interested bidders from March 8, 2019 to 11:00 a.m. of April 4, 2019, at the address stated below upon payment of the applicable fee, pursuant to the latest Guidelines issued by the GPPB, in the amount of FOUR THOUSAND PESOS (P4,000.00). It may also be downloaded free of charge, from the website of the Philippine Government Electronic Procurement System (PhilGEPS) and at the PICC website, <https://www.picc.gov.ph>, provided that participating Bidders shall pay the applicable fee for the Bidding Documents, not later than the submission of their bids.

The PICC-BAC will hold a Pre-Bid Conference on March 19, 2019 at 11:00 a.m., at the PICC BAC Conference Room, Ground Floor, Delegation Building, which shall be open to prospective bidders. Bids must be duly received by the BAC Secretariat at the address specified below on or before 11:00 am. of April 4, 2019. Bids must be accompanied by a bid security in any of the acceptable forms and in the amount stated in **ITB** Clause 18.

Bid opening shall be conducted on April 4, 2019, at 11:00 a.m. at the PICC BAC Conference Room, Ground Floor, Delegation Building, PICC. Bids will be opened in the presence of the bidders' representatives who choose to attend. Late bids shall not be accepted.

In case the Pre-bid Conference, the deadline for the submission of Bid Documents and the opening of bids fall on a non-working day, legal holiday or special non-working holiday, the activity involved shall be moved to 2:00 p.m. of the next working day.

The PICC reserves the right to reject any and all bids, declare a failure of bidding, or not award the contract at any time prior to contract award in accordance with Section 41 of RA 9184 and its IRR, without thereby incurring any liability to the affected bidder or bidders.

For further information, please refer to:

BIDS AND AWARDS COMMITTEE (BAC)
PHILIPPINE INTERNATIONAL CONVENTION CENTER
PICC Complex, 1307 Pasay City
7894758, 7894759 and 7894760
Telefax No. 7894761

MELPIN A. GONZAGA
Chairman

Section III. Bid Data Sheet

Section III - Bid Data Sheet

ITB Clause	
1.1	<p>The Procuring Entity is <i>PHILIPPINE INTERNATIONAL CONVENTION CENTER</i>.</p> <p>The name of the Contract is <i>SUPPLY OF LABOR AND MATERIALS FOR THE CONSTRUCTION OF GARBAGE CONTAINER AND STORAGE AREA FOR HAZARDOUS MATERIALS</i>.</p>
2	<p>The Funding Source is: <i>PICC Approved Budget for CY 2017</i></p> <p>The name of the Project is <i>SUPPLY OF LABOR AND MATERIALS FOR THE CONSTRUCTION OF GARBAGE CONTAINER AND STORAGE AREA FOR HAZARDOUS MATERIALS</i>.</p>
3.1	No further instructions.
5.1	No further instructions.
5.2	Bidding is restricted to eligible bidders as defined in ITB Clause 5.1.
5.4(a)	No further instructions.
5.4(b)	For this purpose, similar contracts shall refer to vertical construction or fabrication works within the last three (3) years from the deadline of submission and opening of bids.
8.1	Subcontracting is not allowed.
8.2	Not applicable.
9.1	The Procuring Entity will hold a pre-bid conference for this Project on March 19, 2019, 11:00 a.m. at <i>BAC Conference Room, G/F, Delegation Building</i> .
10.1	<p>The Procuring Entity's address is:</p> <p style="text-align: center;"><i>Philippine International Convention Center PICC Complex, 1307 Pasay City</i></p> <p><i>For this purpose, the contact person is:</i></p> <p style="text-align: center;"><i>Engr. Alberto C. Gonzales Asst. Director, BSD-TSD</i></p>
10.4	No further instructions.
12.1(a)(i)	Valid and current PhilGEPS Registration – Platinum membership
12.1(a)(ii)	<p>1. Duly signed Statement of all Ongoing Government & Private Construction Contracts including contracts awarded but not yet started</p> <p>2. Duly signed statement of the Single Largest Completed Contract (SLCC)</p>
12.1(a)(iii)	Valid PCAB license and registration for the type and cost of the contract for this project. For JV, provide a JV license issued by PCAB.

	The PCAB Registration for this project is with Principal Classification in General Engineering/Building at least Category "C & D".																					
12.1(b)(ii.2)	<p>The minimum work experience requirements for key personnel are the following:</p> <table border="1"> <thead> <tr> <th>Key Personnel</th> <th>General Experience</th> </tr> </thead> <tbody> <tr> <td>Project Engineer: Licensed Civil Engineer or Architect</td> <td>Must have at least 3-years of experience in vertical construction of commercial, institutional and industrial building</td> </tr> <tr> <td>Project Foreman: Engineering or Architecture under-graduate or Vocational graduate</td> <td>Must have at least 3-years of experience in vertical construction of commercial, institutional and industrial building</td> </tr> </tbody> </table>	Key Personnel	General Experience	Project Engineer: Licensed Civil Engineer or Architect	Must have at least 3-years of experience in vertical construction of commercial, institutional and industrial building	Project Foreman: Engineering or Architecture under-graduate or Vocational graduate	Must have at least 3-years of experience in vertical construction of commercial, institutional and industrial building															
Key Personnel	General Experience																					
Project Engineer: Licensed Civil Engineer or Architect	Must have at least 3-years of experience in vertical construction of commercial, institutional and industrial building																					
Project Foreman: Engineering or Architecture under-graduate or Vocational graduate	Must have at least 3-years of experience in vertical construction of commercial, institutional and industrial building																					
12.1(b)(iii.3)	<p>The minimum major equipment requirements are the following:</p> <table border="1"> <thead> <tr> <th>Item No.</th> <th>Number of units required</th> <th>Description of Equipment</th> </tr> </thead> <tbody> <tr> <td>1</td> <td>One (1) unit</td> <td>One (1)- Bagger mixer</td> </tr> <tr> <td>2</td> <td>Two (1) units</td> <td>½" diam. Concrete Poker Vibrator</td> </tr> <tr> <td>3</td> <td>One (1) unit</td> <td>Bar cutter, can cut 16mm. Re-bars</td> </tr> <tr> <td>4</td> <td>One (1) unit</td> <td>Plate compactor, 2,495 vertical force</td> </tr> <tr> <td>5</td> <td>One (1) unit</td> <td>Welding Machine, inverter-type, 200A</td> </tr> <tr> <td>6</td> <td>One (1) unit</td> <td>Elf truck, 6-wheeler truck</td> </tr> </tbody> </table> <p>Such equipment shall be made available for verification and inspection at the place specified by the Lowest Complying Bidder during the post-qualification period.</p>	Item No.	Number of units required	Description of Equipment	1	One (1) unit	One (1)- Bagger mixer	2	Two (1) units	½" diam. Concrete Poker Vibrator	3	One (1) unit	Bar cutter, can cut 16mm. Re-bars	4	One (1) unit	Plate compactor, 2,495 vertical force	5	One (1) unit	Welding Machine, inverter-type, 200A	6	One (1) unit	Elf truck, 6-wheeler truck
Item No.	Number of units required	Description of Equipment																				
1	One (1) unit	One (1)- Bagger mixer																				
2	Two (1) units	½" diam. Concrete Poker Vibrator																				
3	One (1) unit	Bar cutter, can cut 16mm. Re-bars																				
4	One (1) unit	Plate compactor, 2,495 vertical force																				
5	One (1) unit	Welding Machine, inverter-type, 200A																				
6	One (1) unit	Elf truck, 6-wheeler truck																				
13.1	No additional Requirements																					
13.1(b)	The Financial Component shall be submitted together with the Bill of Quantities																					
13.2	The ABC is THREE MILLION FORTY-FOUR THOUSAND NINE HUNDRED EIGHTY-EIGHT PESOS AND TWENTY-NINE CENTAVOS (P3,044,988.29). Any bid with a financial component exceeding this amount shall not be accepted.																					
14.2	No further instructions.																					
15.4	No further instruction.																					
16.1	The bid prices shall be quoted in Philippine Pesos.																					
16.3	No further instructions.																					
17.1	Bids will be valid until One Hundred Twenty (120) calendar days from the date of submission and opening of bids.																					

18.1	<p>The bid security shall be in the form of a Bid Securing Declaration or any of the following forms and amounts:</p> <ol style="list-style-type: none"> 1. The amount of not less than P60,899.76 if bid security is in cash, cashier's/manager's check, bank draft/guarantee or irrevocable letter of credit; 2. The amount of not less than P152,249.41, if bid security is in Surety Bond.
18.2	<p>The bid security shall be valid until <i>One Hundred Twenty (120) calendar days from the date of submission and opening of bids.</i></p>
20.3	<p>Each Bidder shall submit <i>One (1) original and two (2) copies of the first and second components of its bid.</i></p>
21	<p>The address for submission of bids:</p> <p style="text-align: center;">PHILIPPINE INTERNATIONAL CONVENTION CENTER PICC-BAC SECRETARIAT OFFICE Ground Floor, Delegation Building</p> <p>The deadline for submission of bids is <i>April 4, 2019 at 11:00 a.m.</i></p>
24.1	<p>The place of bid opening:</p> <p style="text-align: center;">PICC-BAC CONFERENCE ROOM Ground Floor, Delegation Building</p> <p>The date and time of bid opening is <i>April 4, 2019 at 11:00 a.m.</i></p>
24.2	<p>No further instructions.</p>
24.3	<p>No further instructions.</p>
27.3	<p>Partial bid is not allowed. The infrastructure project is packaged in a single lot and the lot shall not be divided into sub-lots for the purpose of bidding, evaluation, and contract award.</p>
27.4	<p>No further instructions.</p>
28.2	<p>Post-Qualification Documents:</p> <p>Within a non-extendible period of five (5) calendar days from receipt of the notice from the BAC that it submitted the Lowest Calculated Bid, The Bidder shall submit the following;</p> <ol style="list-style-type: none"> 1. 2017 Income and Business Tax returns filed and paid through Electronic Filing and Payment System (eFPS). 2. Sections III and V of the Bid Documents, signed on each and every page by the bidder's authorized representative; 3. Company profile with organizational chart and sketch of office location; 4. Resume of the Project Engineer and the Project Foreman who will be assigned to the project.

	<ol style="list-style-type: none"> 5. Names/s of authorized representatives who will represent, execute, attend and transact pertaining to the project in behalf/in the absence of the Contractor (Owner); 6. List of completed horizontal construction within the last three (3) years with contact person and telephone numbers; 7. List of the major equipment, proof of ownership/certificate to procure/lease contract of such equipment; 8. Certification from PICC Building Services Division that the participating bidder has conducted inspection of the subject requirements; and 9. Certificate of Satisfactory Completion and Acceptance of previous PICC projects undertaken within the last three (3) years, if any.
31.4(f)	<p>The following documents shall be submitted, together with the Performance Bond, within ten (10) calendar days after the receipt of the Notice of Award. Such documents shall form part of the contract;</p> <ol style="list-style-type: none"> 1. Construction Schedule and S-curve; 2. Construction Method; 3. Construction Safety and Health Program; and 4. PERT/CPM.
32.2	<p>The performance security shall be in the following amount:</p> <ol style="list-style-type: none"> 1. The amount of (10% of the total contract amount), if performance security is in cash, cashier's/manager's check or bank draft/guarantee issued by a Universal or Commercial Bank; 2. The amount of (30% of the total contract amount), if performance security is in Surety Bond duly certified by the Insurance Commission as authorized to issue such security.

Section V. Special Conditions of Contract

Section V- Special Conditions of Contract

GCC Clause	
1.17	The Intended Completion Date is within SIXTY (60) CALENDAR DAYS reckoned seven (7) calendar days after the receipt of the Notice to Proceed.
1.22	The Procuring Entity is: PHILIPPINE INTERNATIONAL CONVENTION CENTER PICC Complex, 1307 Pasay City
1.23	The Procuring Entity's Representative is: ENGR. ALBERTO C. GONZALES Asst. Director, BSD-TSD
1.24	The Site is located at <i>Secretariat Parking, PICC</i>
1.28	The Start Date is seven (7) calendar days from the date of receipt of the Notice to Proceed.
1.31	The Works consist of furnishing of all labor, materials, equipment and other incidental necessary or convenient to the complete execution for the construction of garbage container and storage area for hazardous materials.
5.1	The PICC shall give possession of all parts of the site to the Contractor beginning on the date of effectivity of contract until the date of its termination and/or project completion.
6.5	The Contractor shall employ the following Key Personnel : <i>[List key personnel by name and designation]</i> NOTE: The names of the Key Personnel and their designation shall be filled out by winning contractor prior to contract signing.
7.4(c)	No further instructions.
7.7	No further instructions.
8.1	Subcontracting is not allowed.
10	None
12.2	The defects and liability period shall be one (1) year from contract completion up to final acceptance.
12.3	No further instructions.
12.5	Warranty:

	One (1) year from project completion.								
12.6	<p>The Contractor shall be required to put up a warranty security in the form of cash, bank guarantee, letter of credit, GSIS or surety bond callable on demand, in accordance with the following schedule:</p> <table border="1"> <thead> <tr> <th>Form of Warranty</th> <th>Amount of Warranty Security Not less than the Percentage (%) of Total Contract Price</th> </tr> </thead> <tbody> <tr> <td>(a) Cash or letter of credit issued by Universal or Commercial bank: provided, however, that the letter of credit shall be confirmed or authenticated by a Universal or Commercial bank, if issued by a foreign bank</td> <td>Five Percent (5%)</td> </tr> <tr> <td>(b) Bank guarantee confirmed by Universal or Commercial bank: provided, however, that the letter of credit shall be confirmed or authenticated by a Universal or Commercial bank, if issued by a foreign bank</td> <td>Ten Percent (10%)</td> </tr> <tr> <td>(c) Surety bond callable upon demand issued by GSIS or any surety or insurance company duly certified by the Insurance Commission</td> <td>Thirty Percent (30%)</td> </tr> </tbody> </table> <p>The warranty security shall be effective for one (1) year from the date of issuance of the Certificate of Final Acceptance.</p>	Form of Warranty	Amount of Warranty Security Not less than the Percentage (%) of Total Contract Price	(a) Cash or letter of credit issued by Universal or Commercial bank: provided, however, that the letter of credit shall be confirmed or authenticated by a Universal or Commercial bank, if issued by a foreign bank	Five Percent (5%)	(b) Bank guarantee confirmed by Universal or Commercial bank: provided, however, that the letter of credit shall be confirmed or authenticated by a Universal or Commercial bank, if issued by a foreign bank	Ten Percent (10%)	(c) Surety bond callable upon demand issued by GSIS or any surety or insurance company duly certified by the Insurance Commission	Thirty Percent (30%)
Form of Warranty	Amount of Warranty Security Not less than the Percentage (%) of Total Contract Price								
(a) Cash or letter of credit issued by Universal or Commercial bank: provided, however, that the letter of credit shall be confirmed or authenticated by a Universal or Commercial bank, if issued by a foreign bank	Five Percent (5%)								
(b) Bank guarantee confirmed by Universal or Commercial bank: provided, however, that the letter of credit shall be confirmed or authenticated by a Universal or Commercial bank, if issued by a foreign bank	Ten Percent (10%)								
(c) Surety bond callable upon demand issued by GSIS or any surety or insurance company duly certified by the Insurance Commission	Thirty Percent (30%)								
13	No additional provision.								
18.3(h)(i)	No further instructions.								
21.2	<p>The Arbiter is:</p> <p>Construction Industry Arbitration Commission</p>								
29.1	No day-works are applicable to the contract.								
31.1	The Contractor shall submit the Program of Work to the PICC Representative within seven (7) calendar days after receipt of the Notice of Award.								
34.3	The Funding Source is the <i>2017 Approved PICC Budget</i> .								
39.1	The amount of the advance payment is fifteen percent (15%) of the Contract Price in lump sum. Advance payment shall be made only upon submission to and acceptance of an irrevocable letter of credit of equivalent value from a commercial bank, a bank guarantee or a surety								

	<p>bond callable upon demand, issued by a surety or insurance company duly licensed by the Insurance Commission and confirmed by PICC.</p>
40.1	<p>Payment</p> <p>1. Payment to be made shall be in three (3) schedules.</p> <p>1.1 First payment shall be equivalent to at least twenty percent (20%) of the work that has been accomplished as certified by the end-user.</p> <p>Payment shall only be processed upon submission of the following:</p> <ul style="list-style-type: none">• Letter request of the CONTRACTOR for the release of payment for work accomplished.• Joint inspection inventory report of the CONTRACTOR and PICC's Representative on the condition of the adjoining area; and existing utilities prior to commencement of works.• Breakdown of work accomplished as validated and certified by PICC's representative.• Photographs of work accomplished.• Key plan highlighting work accomplished.• Invoice <p>1.2 Second payment shall be equivalent to at least seventy percent (70%) of the work that has been accomplished (Accomplishment Last Period (20%) + Accomplishment This Period (50%)).</p> <p>Payment shall only be processed upon submission of the following:</p> <ul style="list-style-type: none">• Letter request of the CONTRACTOR for the release of payment for work accomplished.• Breakdown of work accomplished as validated and certified by PICC's representative.• Photographs of work accomplished.• Key plan highlighting work accomplished during the last period and accomplishment for the requested period.• Invoice <p>1.3 Final payment shall be equivalent to at least thirty percent (30%) of the work accomplished made after full accomplishment of the project cost. Payment shall be processed upon submission of the following:</p> <ul style="list-style-type: none">• Letter request of the CONTRACTOR for the release of payment for work accomplished.• Breakdown of work accomplished as validated and certified by PICC's representative.• Photographs of work accomplished.

	<ul style="list-style-type: none"> • Key plan highlighting work accomplished during the last period and accomplishment for the requested period. • Joint inspection inventory report of the CONTRACTOR and PICC's Representative on the condition of the adjoining area; and existing utilities prior to commencement of works. • Certificate of Completion • As-Built Plan in a soft and hard copy. The hard copy shall be in A3 bond size, three (3) copies signed by the CONTRACTOR and PICC authorized representative. • Invoice <p>2. Materials and equipment delivered on the site but not completely put in place shall not be included for payment.</p> <p>3. Payments are subject to retention of ten percent (10%) referred to as the "retention money". It shall be due for release upon final acceptance of the works, which is one (1) year from project completion, subject to submission of warranty security, the form and amount as stated in SCC 12.6.</p> <p>4. The Contractor may request the substitution of the retention money with irrevocable standby letter of credit from a commercial bank, bank guarantees or surety bonds callable on demand, of amount equivalent to ten percent (10%) of the total contract amount</p> <p>5. PICC shall pay the CONTRACTOR the amounts certified by PICC's Representative within thirty (30) calendar days from the date request for payment was received. No payment interest shall be made for the delayed payments and adjustments.</p>
51.1	The date by which "as built" drawings are required is upon completion of project.

Section VI. Specifications

I. GENERAL SCOPE OF WORKS

The works shall be supply of all materials, labor, tools, equipment and other services incidental necessary for the construction of garbage containers and storage for hazardous materials at the garbage disposal area, Secretariat Parking.

The following features of the work shall be performed, but not limited to the following:

1.0 General Requirements and Preliminaries

1.1 Mobilization

Manpower, tools, equipment and temporary warehouse.

1.2 Securing of Performance Surety Bond and Special Bank Guarantee certificate.

1.3 Health and Safety requirements

- a. Personal Protective Equipment (PPE) for workers
- b. Installation of 2 - safety signage, same as the PICC standard signage, 22" x 32".
- c. Provide board-up, (painted Corrugated GI Sheet) to cover the construction area.
- d. Provide portable fire extinguishers (at least 2 units) and other fire extinguishing materials
- e. Provide portalet for the whole duration of the project

1.4 Demobilization

Manpower, tools, equipment, temporary warehouse, including hauling-out of construction debris.

2.0 Construction of garbage containers

2.1 Provide garbage containers with an area of 217.50 square meters. Each garbage containers consists of three (3) section: wet section, dry section and recyclable section. Please refer to drawing for the dimension of each section.

2.2 Structural/Concrete Works

2.2.1 Footing: Use 12mm reinforcement bars. Please refer to plan for details

2.2.2 Tie Beam: Use 12mm for top bars and bottom bars with 10mm stirrups. Please refer to plan for details.

2.2.3 Columns: Use 12mm vertical bars with 10mm ties. Please refer to plan for details.

2.2.4 Slab-on-fill: Backfilling should be layer of 6" well-compacted

Use 10mm temperature reinforcement bars

Please refer to plan for details.

- 2.2.5 Roof Beam: Use 12mm reinforcement bars for top and bottom bars with 10mm stirrups. Please refer to plan for details.
- 2.2.6 Roof slab: Use 12mm reinforcement bars for top and bottom bars with 10mm stirrups. Please refer to plan for details
Apply waterproofing membrane. Submit brochures and sample board prior to application. Please refer to plan for details.
- 2.2.7 Trench drain: Provide trench canal with cover and terminate to the nearest sewer lines. Please refer to plan for details
- 2.3 Architectural Works
 - 2.3.1 Masonry works: Provide 6" CHB enclosure of each container with 12mm dowel reinforcement bars and plastered finish.
 - 2.3.2 Painting Works: Exterior and interior (wet garbage container), color for approval prior to application.
 - 2.3.3 Steel folding door, including accessories.
 - 2.3.4 Louver blocks
- 2.4 Electrical Works
 - 2.4.1 Roughing-ins and electrical fixtures
- 2.5 Sewer lines
- 2.6 Restoration of affected structures.
- 2.7 Cleaning and hauling of construction debris outside PICC Complex.
- 3.0 Construction of storage for hazardous materials
 - 3.1 Structural/Concrete Works
 - 3.1.1 Footing: Use 12mm reinforcement bars. Please refer to plan for details
 - 3.1.2 Tie Beam: Use 12mm for top bars and bottom bars with 10mm stirrups. Please refer to plan for details.
 - 3.1.3 Columns: Use 12mm vertical bars with 10mm ties. Please refer to plan for details.
 - 3.1.4 Slab-on-fill: Backfilling should be layer of 6" well-compacted
Use 10mm temperature reinforcement bars
Please refer to plan for details.
 - 3.1.5 Roof Beam: Use 12mm reinforcement bars for top and bottom bars with 10mm stirrups. Please refer to plan for details.
 - 3.1.6 Roof slab: Use 12mm reinforcement bars for top and bottom bars with 10mm stirrups. Please refer to plan for details

Apply waterproofing membrane. Submit brochures and sample board prior to application. Please refer to plan for details.
 - 3.2 Architectural Works
 - 3.2.1 Masonry works: Provide 6" CHB enclosure of each container with 12mm dowel reinforcement bars and plastered finish.
 - 3.2.2 Painting Works: Exterior color for approval prior to application.

- 3.2.3 Double swing door, including accessories.
- 3.2.4 Awning window (2400mm x 600mm)
- 3.3 Electrical Works
 - 3.3.1 Roughing-ins and electrical fixtures
- 3.4 Sewer lines
- 3.5 Restoration of affected structures.
- 3.6 Cleaning and hauling of construction debris outside PICC Complex.

II. GENERAL CONDITIONS:

A. Interpretation

1. The Contract Documents, Specifications and Drawings are mutually complimentary. What is noted in one although not shown in other shall be considered contained in all, in case of conflict. The Specifications shall prevail over the Drawings. The documents forming the Contract shall be interpreted in the following order of priority:
 - a. Contract/Construction Agreement
 - b. Letter of Acceptance
 - c. Contractor's Bid
 - d. Special Conditions of the Contract
 - e. Specifications
 - f. Drawings
 - g. Bill of Quantities
 - h. Any other document listed in the Special Conditions of the Contract as forming part of the Contract.
2. The CONTRACTOR shall examine all the issued documents relating to the work and must have verified all the existing conditions at the site. No consideration will be given for any alleged misunderstanding or misinterpretation of the specifications and materials to be used or work to be done

B. Possession of Site.

1. The CONTRACTOR admits that he has inspected the site where the work will be performed; that he has informed himself fully as to the conditions which might affect the nature, extent and cost of the work required; that PICC shall in no way responsible or any costs or expenses which may develop on account of failure of the CONTRACTOR to make accurate examination of present or future factors that may affect the cost of execution.
2. Tapping of equipment and other related works shall be properly coordinated with PICC's Representative for provision of electrical power source of outlet and assistance. For this purpose, the CONTRACTOR shall provide a sub-meter for power consumptions and shall be billed accordingly to the total kilowatt utilized.
3. The PICC shall allow the CONTRACTOR to tap from the existing water connections to be used in the construction of shed. For this purpose, the CONTRACTOR shall

provide a sub-meter, with the supervision of PICC in the installation works. The sub-meter will determine the total water consumed and shall be billed accordingly.

C. Contractor's Obligation

1. The above mentioned features of the work do not, in any way limit the responsibilities of the contractor to the general description of the work. The CONTRACTOR shall perform all works fully to the intent of construction of garbage containers and storage area for hazardous materials at the garbage disposal area.
2. A joint inspection must be conducted in between the Contractor and PICC's Representative, on the specific works to be done on the construction of garbage containers and storage area for hazardous materials at the garbage disposal area.
3. The CONTRACTOR is required to inspect and examine the site and the surroundings of the proposed project to arrive at an estimate of the labor, materials, equipment, facilities and services necessary to carry out the works.
4. The CONTRACTOR shall submit sample of materials and MSDS of all materials for approval prior to any works to be started / installed.
5. The CONTRACTOR shall commence execution of the works on the Start Date and shall carry out the works in accordance with the program of work submitted by the CONTRACTOR, as updated with the approval of PICC's Representative and complete them by the intended completion date.
6. The CONTRACTOR shall provide all supervision, labor, materials, plant and Contractor's equipment, which may be required.
7. The CONTRACTOR shall be liable to all fire and accident claims and other related claims arising from the injuries and damages, which occurred in the vicinity.
8. The CONTRACTOR shall free the PICC and its personnel from and against all liability for damages arising from injuries or liabilities to persons or damages to property by any act of omissions of the contractor including any and all expenses which may be incurred by PICC and its personnel in the defense of any claim, action or suit.
9. Any work that may affect the operation, security and image of the Center shall be coordinated properly to PICC's Representative and shall be done in accordance with the Center's approved schedule.
10. Cost of rework and restoration or replacement of all damaged properties due to CONTRACTOR'S poor workmanship or negligence shall be borne by the Contractor.
11. The CONTRACTOR must submit list of personnel assigned to the project including their NBI clearance/Police Clearance before commencing the above scope of works.
12. The CONTRACTOR's personnel/workers must wear at all times their company's ID while working inside the Center.

D. Workmanship

The work throughout shall be executed in the best and most thorough manner to the satisfaction of PICC and its engineers and supervisors who will jointly interpret the meaning of the scope of work and its conditions and shall have the power to reject any work, method of accomplishing every part of work and material used which in their judgment are not in full accordance therewith and are disadvantageous to PICC.

E. Liquidated Damages

In case of delay in the completion period inclusive of duly granted time extensions, if any, the Contractor shall be liable for damages and shall pay the PICC for liquidated damages in an amount equivalent to at least one tenth (1/10) of one percent (1%) of the cost of the unperformed services for every day of delay.

The maximum deduction shall be ten percent (10%) of the amount of contract. Once the cumulative amount of liquidated damages reaches ten percent (10%) of the amount of the Contract, the procuring entity shall rescind the award without prejudice to other courses of action and remedies open to it.

Section VII. Drawings

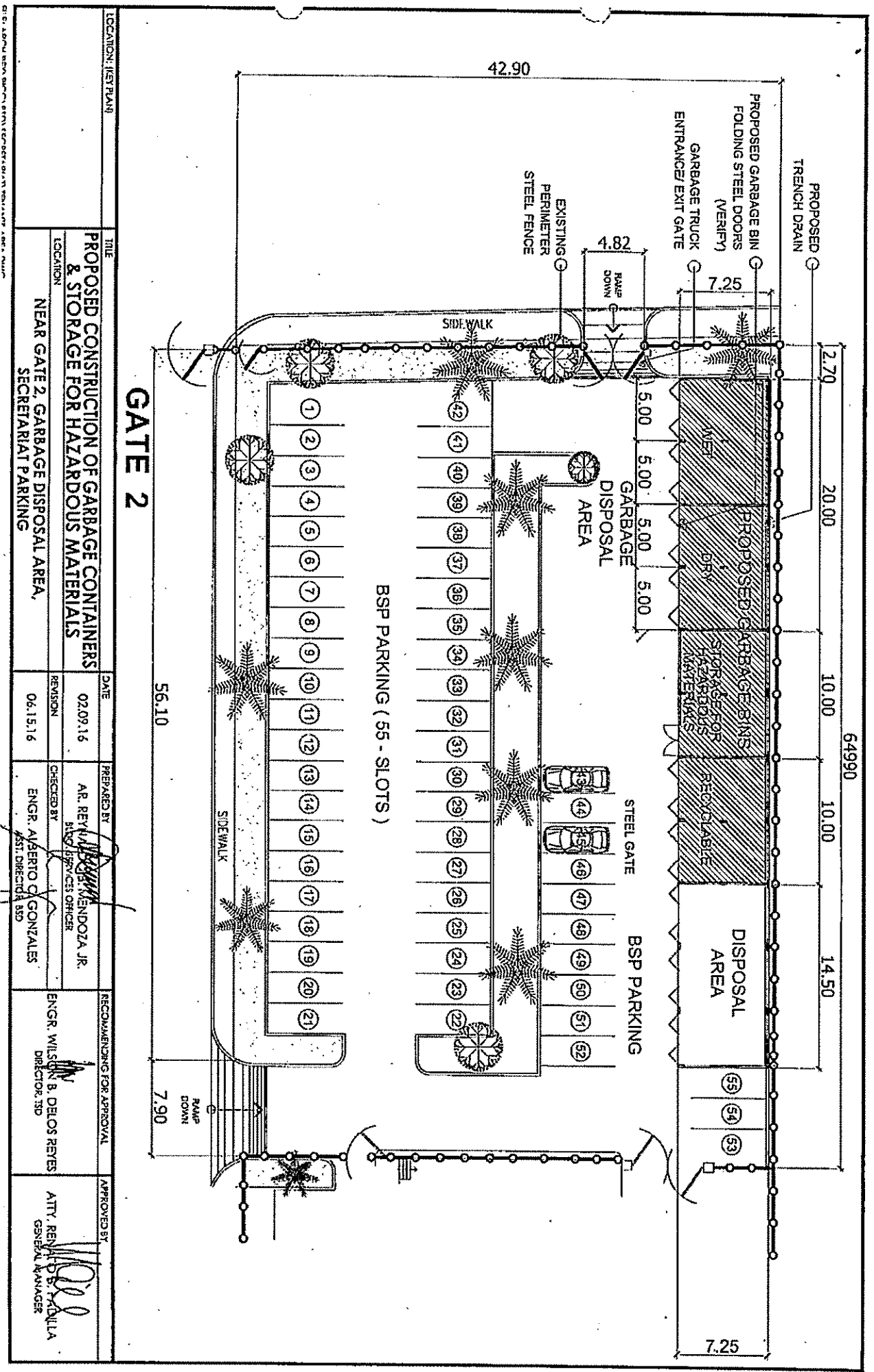

GATE 2

LOCATION: (SEE PLAN)	TITLE	DATE	PREPARED BY	RECOMMENDING FOR APPROVAL	APPROVED BY
	PROPOSED CONSTRUCTION OF GARBAGE CONTAINERS & STORAGE FOR HAZARDOUS MATERIALS	02.09.16	AR. REVILLA MENDOZA JR. SITE SERVICES CHIEF	ENGR. WILSON B. DELOS REYES DIRECTOR TSD	ATTY. REVILLA GENERAL MANAGER
LOCATION	REVISION		CHECKED BY		
NEAR GATE 2, GARBAGE DISPOSAL AREA, SECRETARIAT PARKING	06.15.16		ENGR. ALBERTO GONZALES ASST. DIRECTOR SSD		

BY: LEONARDO SANCHEZ, ENGR., REG. NO. 17778, CIVIL ENGR., 2002, PHIL.



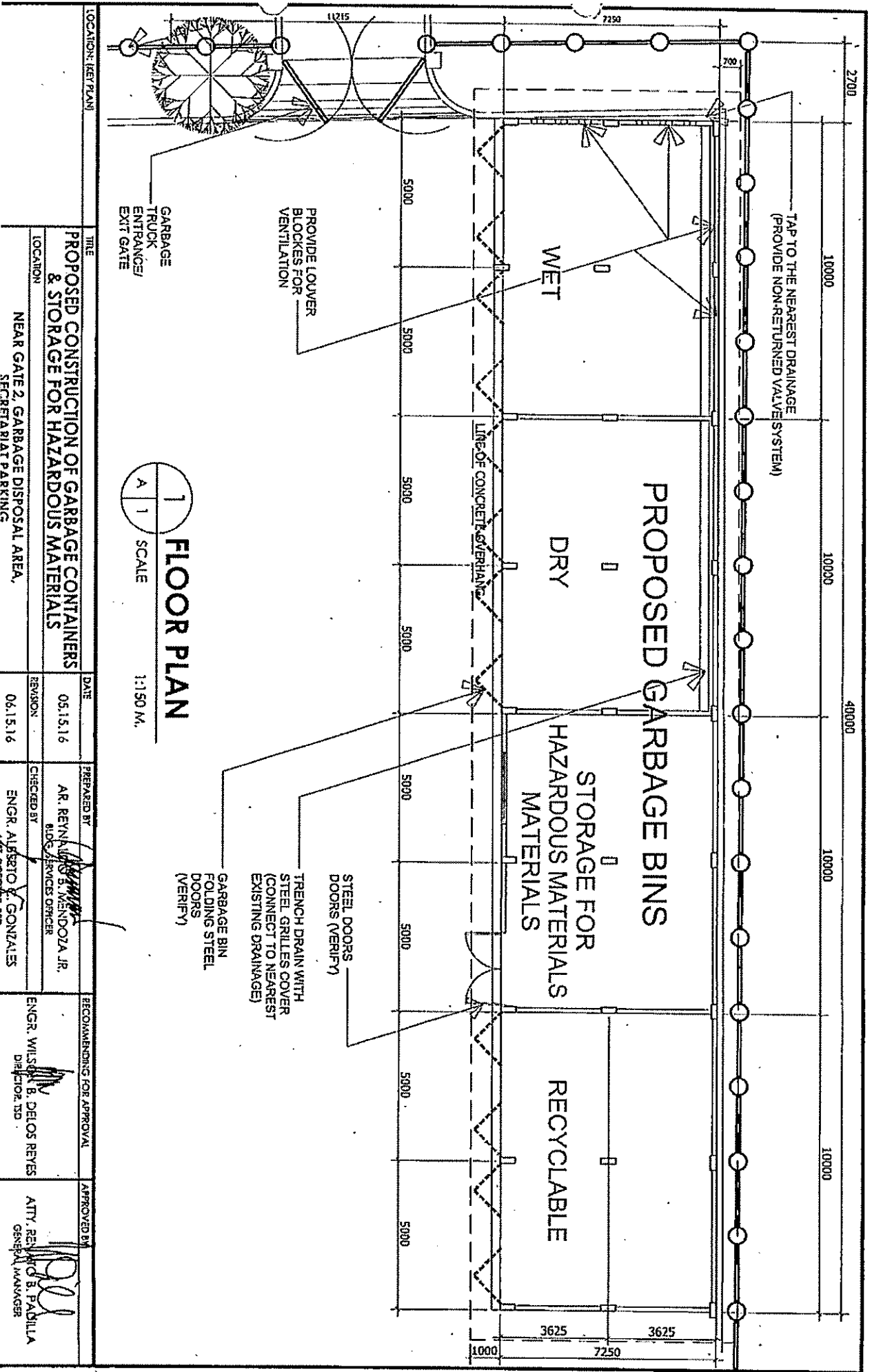

1
FLOOR PLAN
 SCALE 1:150 M.

LOCATION: RESTAURANT	TITLE	DATE	PREPARED BY	RECOMMENDING FOR APPROVAL	APPROVED BY
	PROPOSED CONSTRUCTION OF GARBAGE CONTAINERS & STORAGE FOR HAZARDOUS MATERIALS	05.15.16	AR. REYNALDO S. MENDOZA, JR. PLC SERVICES OFFICER	ENGR. WILSON B. DELOS REYES DIRECTOR, ISD	ATTY. RENATO B. PABILLA GENERAL MANAGER
	LOCATION	REVISION	CHECKED BY		
	NEAR GATE 2, GARBAGE DISPOSAL AREA, SECRETARIAT PARKING	06.15.16	ENGR. ALBERTO V. GONZALES		

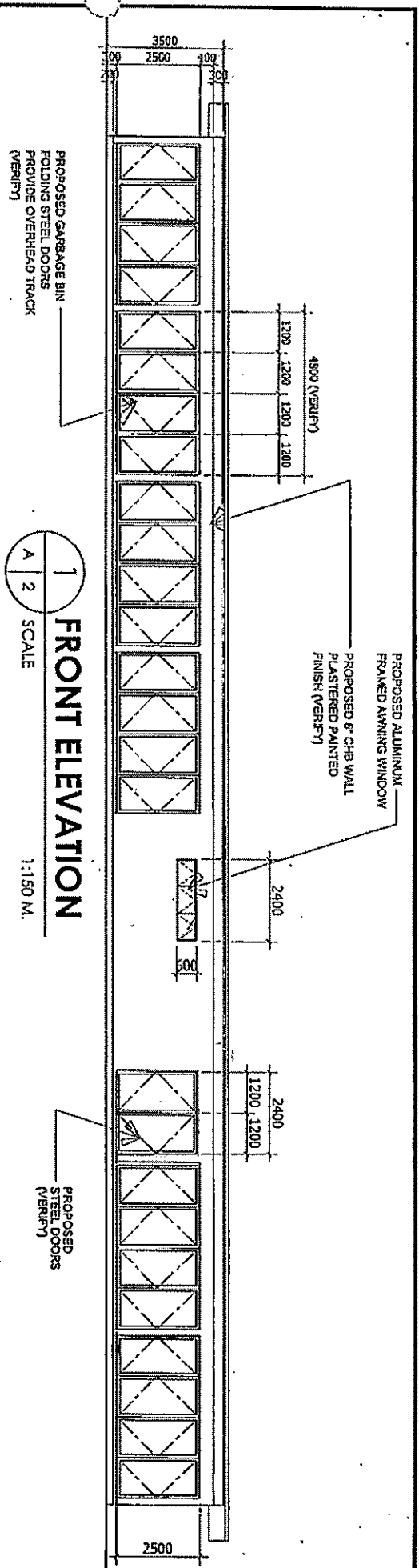

1 FRONT ELEVATION
 SCALE 1:150 M.

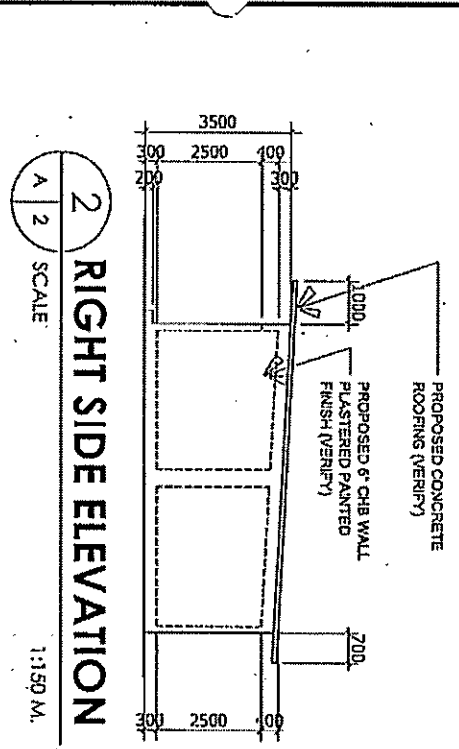

2 RIGHT SIDE ELEVATION
 SCALE 1:150 M.

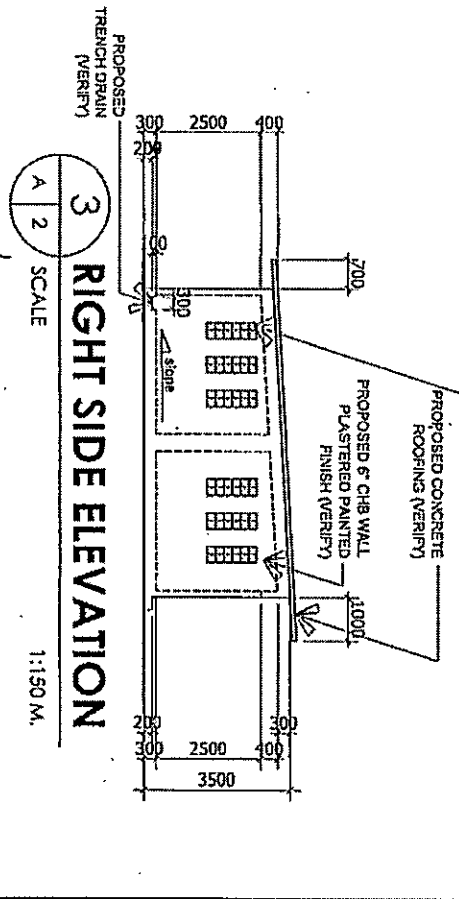

3 RIGHT SIDE ELEVATION
 SCALE 1:150 M.

LOCATION: (SEE PLAN)	TITLE	DATE	PREPARED BY	RECOMMENDING FOR APPROVAL	APPROVED BY
	PROPOSED CONSTRUCTION OF GARBAGE CONTAINERS & STORAGE FOR HAZARDOUS MATERIALS	05.15.16	A.R. REYNOLDO MENDOZA JR. BIDG. SERVICES OFFICER	ENGR. WILSON B. DELOS REYES DIRECTOR, ISD	ATTY. BENJAMIN B. PADILLA GENERAL MANAGER
	NEAR GATE 2, GARBAGE DISPOSAL AREA, SECRETARIAT PARKING	06.15.16	ENGR. ALBERTO C. GONZALES EST. DIRECTOR, ISD		

FILE: ARCH REV\PCO\BDD\SECRETARIAT\PHCC COMPLEX PARKING.DWG

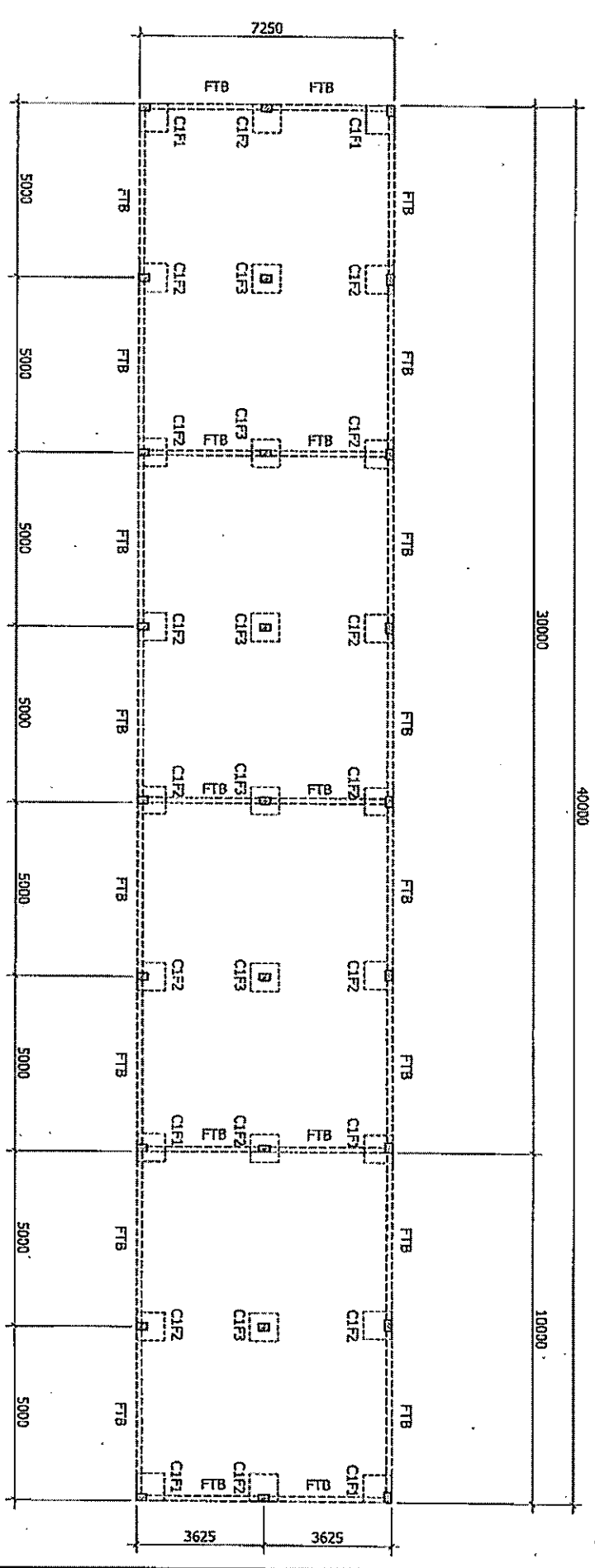

1
 FOUNDATION PLAN
 SCALE 1:150 M.

LOCATION: REV PLAN	TITLE	DATE	PREPARED BY	RECOMMENDING FOR APPROVAL	APPROVED BY
	PROPOSED CONSTRUCTION OF GARBAGE CONTAINERS & STORAGE FOR HAZARDOUS MATERIALS	05.15.16	A.R. REYNOLDO S. MENDOZA JR. RSD SERVICES CHFCR	ENGR. WILSON B. DELOS REYES DIRECTOR RSD	ATTY. RANILDO B. BELLA GENERAL MANAGER
	LOCATION: NEAR GATE 2, GARBAGE DISPOSAL AREA, SECRETARIAT PARKING	REVISION: 06.15.16	CHECKED BY: ENGR. ALBERTO C. GONZALES ASST. DIRECTOR RSD		

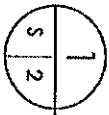
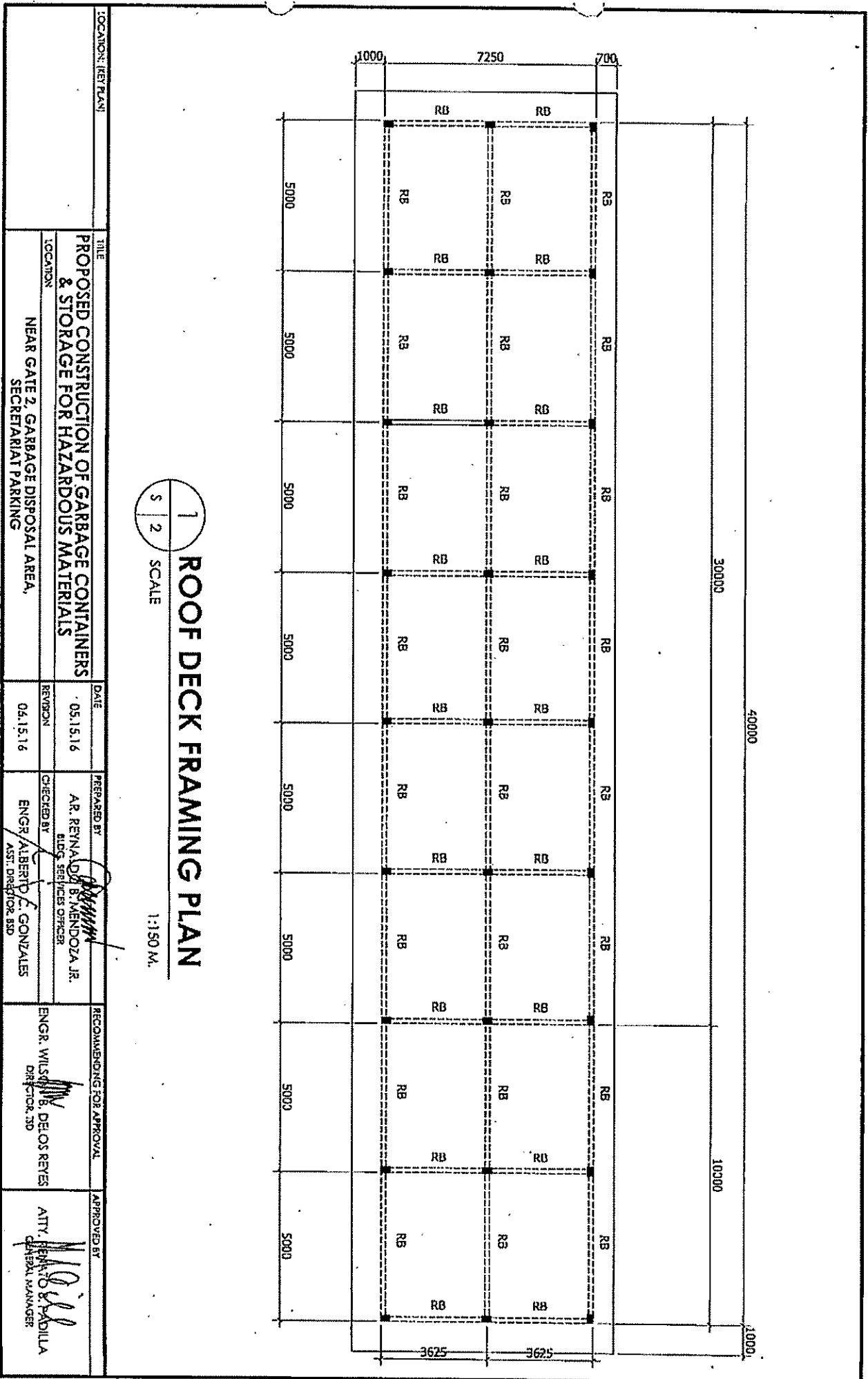

ROOF DECK FRAMING PLAN

SCALE

1:150 M.

LOCATION: (REF PLAN)		TITLE		DATE		PREPARED BY		RECOMMENDING FOR APPROVAL		APPROVED BY	
		PROPOSED CONSTRUCTION OF GARBAGE CONTAINERS & STORAGE FOR HAZARDOUS MATERIALS		05.15.16		A.R. REYNALDO B. MENDOZA JR. BLDG. SERVICES OFFICER		ENGR. WILSON B. DELOS REYES DIRECTOR, SD		ATTY. BENITO R. MADILLA GENERAL MANAGER	
LOCATION		REVISION		CHECKED BY							
NEAR GATE 2, GARBAGE DISPOSAL AREA, SECRETARIAT PARKING		06.15.16		ENGR. ALBERTO C. GONZALES AST. DIRECTOR, SSD							

SCHEDULE OF BEAM

BEAM MARK	BEAM DIMENSION		Longitudinal (main) reinforcements						TIES & STIRRUPS	REMARKS
	B	H	REBAR SIZE	LEFT SUPPORT TOP	BOTTOM	MIDSPAN TOP	BOTTOM	RIGHT SUPPORT TOP		
FTB	200	300	12 mm DIA.	2-12 mm DIA.	2-12 mm DIA.	2-12 mm DIA.	2-12 mm DIA.	2-12 mm DIA.	10 mm DIA., 3 @ 50 mm, 4 @ 100 mm, 5 @ 150, REST 200 mm O.C.	RECTANGULAR
RB1	200	300	12 mm DIA.	2-12 mm DIA.	2-12 mm DIA.	2-12 mm DIA.	2-12 mm DIA.	2-12 mm DIA.	10 mm DIA., 3 @ 50 mm, 4 @ 100 mm, 5 @ 150, REST 200 mm O.C.	RECTANGULAR

SUSPENDED FLOOR SLAB SCHEDULE

FLOOR LEVEL	SLAB MARK	THICKNESS IN MM	REBAR SPACING ALONG "SHORT" SPAN						REBAR SPACING ALONG "LONG" SPAN						
			REBAR SIZE	LEFT SUPPORT TOP	BOTTOM	MIDSPAN TOP	BOTTOM	RIGHT SUPPORT TOP	BOTTOM	REBAR SIZE	LEFT SUPPORT TOP	BOTTOM	MIDSPAN TOP	BOTTOM	RIGHT SUPPORT TOP
ROOF SLAB	S1	100	10 mm DIA.	150	300	150	150	300	10 mm DIA.	150	300	150	150	300	300

COLUMN FOOTING SCHEDULE

FOOTING MARK	DIMENSION IN MM			REINFORCEMENT						REMARKS
	L	W	T	ALONG "L"		ALONG "W"				
				TOP	BOTTOM	TOP	BOTTOM	TOP	BOTTOM	
F1	800	800	200	NO TOP BARS	5-12 mm DIA.	NO TOP BARS	5-12 mm DIA.			
F2	800	800	200	NO TOP BARS	6-12 mm DIA.	NO TOP BARS	6-12 mm DIA.			
F3	900	900	200	NO TOP BARS	7-12 mm DIA.	NO TOP BARS	7-12 mm DIA.			

SCHEDULE OF COLUMN

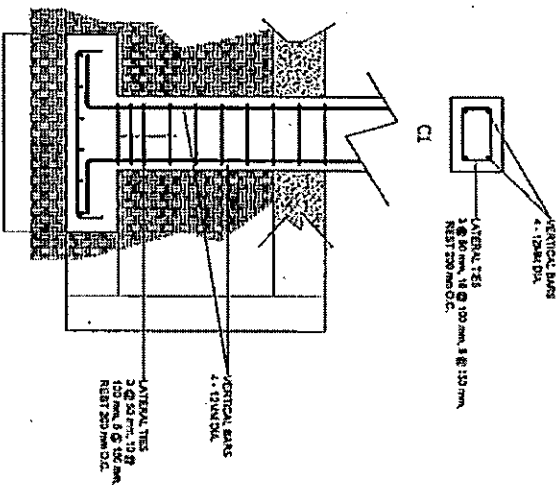

LOCATION: (REV PLAN)	TITLE	DATE	PREPARED BY	RECOMMENDING FOR APPROVAL	APPROVED BY
	PROPOSED CONSTRUCTION OF GARBAGE CONTAINERS & STORAGE FOR HAZARDOUS MATERIALS	05.13.16	A.R. REVINA MENDOZA JR. BLDG. SERVICES OFFICER	ENGR. WILSON B. DELOS REYES DIRECTOR TSD	ATTY. RENANCO PADILLA GENERAL MANAGER
LOCATION	NEAR GATE 2, GARBAGE DISPOSAL AREA, SECRETARIAT PARKING	REVISION	CHECKED BY		
		06.12.16	ENGR. ASERIO G. GONZALES ASST. DIRECTOR, BSD		

Section VIII. Bill of Quantities

Subject : Supply of Labor and Materials for the Construction of Garbage Container and Storage Area for the Hazardous Materials

Item No.	Description of Work	Quantity	Unit	Unit Cost		Total
				Material	Labor	
1.0	Preliminaries					
	Mobilization	1.00	lot			-
	Health and Safety Requirements	1.00	lot			-
	Demobilization	1.00	lot			-
	Sub -total for Item 1					-
2.0	STRUCTURAL					
A.	Footing					
	Demolition of concrete pavement	3.70	m3			-
	Excavation & Hauling	18.50	m3			-
	Backfilling	16.60	m3			-
	Gravel Bed	1.90	m3			-
	Concrete	3.70	m3			-
	Forms	1.50	m2			-
	Rebar					
	12mm Ø	506.90	kg			-
B.	Columns					
	Concrete	9.40	m3			-
	Forms	141.00	m2			-
	Rebar					
	12mm Ø	793.00	kg			-
	10mm Ø	612.10	kg			-
C.	Slab					
	Concrete	87.00	m3			-
	Rebar					
	10mm Ø	1,071.90	kg			-
D.	Tie Beam					
	Concrete	6.80	m3			-
	Rebar					
	12mm Ø	758.30	kg			-
	10mm Ø	527.30	kg			-
E.	Roof Beam					
	Concrete	10.70	m3			-
	Forms	124.70	m2			-
	Rebar					
	12mm Ø	1,204.20	kg			-
	10mm Ø	842.70	kg			-

Prepared by:

 PRINTED NAME and SIGNATURE of
 the Authorized Representative

F.	Roof Slab				
	Concrete	37.38	m3		-
	Forms	373.8	m2		-
	Rebar				
	12mm Ø	1,668.30	kg		-
	Sub -total for Item 2				-
3.0	Architectural				
A.	Masonry				
	6" CHB; including concrete stiffener and reinf.	241.40	m2		-
	Plastering	580.50	m2		-
C.	Painting				
	Exterior	316.30	m2		-
	Interior - wet garbage container	82.40	m2		-
D.	Steel Door & Windows ; including accessories				
	Steel Folding Door (for Garbage container)	6.00	set		-
	Double Swing Door (for Hazardous storage)	1.00	set		-
	Awning Window (2400x600mm) (for Hazardous storage)	1.00	set		-
	Louver Blocks	12.00	set		-
	Sub -total for Item 3				-
4.0	Electrical Works				
	Roughing-ins and Electrical Fixtures	1.00	lot		-
	Sub -total for Item 4				-
5.0	Sewer Lines				
	Sewer lines	1.00	lot		-
	Sub -total for Item 4				-
A.	Direct Cost				
	Material and Labor Cost (Items 1+2+3+4)				-

Prepared by:

 PRINTED NAME and SIGNATURE of
 the Authorized Representative

B.	Indirect Cost					
	Overhead (10% of Direct Cost)					-
	Contingencies and Miscellaneous (5% of Direct Cost)					-
	Contractors Profit (12% of Direct Cost)					-
C.	VAT (12% of Direct Cost + Indirect Cost)					-
GRAND TOTAL COST						-

Prepared By:

 PRINTED NAME and SIGNATURE of the Authorized Representative

Name of Company :

Address :

Date Signed :

Section IX. Bidding Forms

Bid Form

Date: _____

To: PHILIPPINE INTERNATIONAL CONVENTION CENTER

Address: PICC Complex 1307 Pasay City

We, the undersigned, declare that:

- (a) We have examined and have no reservation to the Bidding Documents, including Addenda, for the Contract **SUPPLY OF LABOR AND MATERIALS FOR THE CONSTRUCTION OF GARBAGE CONTAINER AND STORAGE AREA FOR THE HAZARDOUS MATERIALS**;
- (b) We offer to execute the Works for this Contract in accordance with the Bid and Bid Data Sheet, General and Special Conditions of Contract accompanying this Bid;

The total price of our Bid is:

Amount in Words: _____

(P _____), VAT Inclusive.

- (c) Our Bid shall be valid for a period of *120 calendar days* from the date fixed for the Bid submission deadline in accordance with the Bidding Documents, and it shall remain binding upon us and may be accepted at any time before the expiration of that period;
- (d) If our Bid is accepted, we commit to obtain a Performance Security in the amount of *[insert percentage amount]* percent of the Contract Price for the due performance of the Contract;
- (e) Our firm, or suppliers for any part of the Contract, have nationalities from the following eligible countries: *[insert information]*;
- (f) We are not participating, as Bidders, in more than one Bid in this bidding process, other than alternative offers in accordance with the Bidding Documents;
- (g) Our firm, its affiliates or subsidiaries, or suppliers for any part of the Contract, has not been declared ineligible by the Funding Source;
- (h) We understand that this Bid, together with your written acceptance thereof included in your notification of award, shall constitute a binding contract between us, until a formal Contract is prepared and executed; and
- (i) We understand that you are not bound to accept the Lowest Calculated Bid or any other Bid that you may receive.
- (j) We likewise certify/confirm that the undersigned, is the duly authorized representative of the bidder, and granted full power and authority to do, execute and perform any and all acts necessary to participate, submit the bid, and to sign and execute the ensuing contract for the

Supply of Labor and Materials for the Construction of Garbage Container and Storage Area for the Hazardous Materials of the Philippine International Convention Center.

(k) We acknowledge that failure to sign each and every page of this Bid Form, including the Bill of Quantities, shall be a ground for the rejection of our bid.

(l) Attached to the Bid is the Bill of Quantities.

Name: _____

In the capacity of: _____

Signed: _____

Duly authorized to sign the Bid for and on behalf of: _____

Date: _____

PHILIPPINE INTERNATIONAL CONVENTION CENTER
BIDS AND AWARDS COMMITTEE

CHECKLIST OF REQUIREMENTS

**SUPPLY OF LABOR AND MATERIALS FOR THE CONSTRUCTION OF GARBAGE
CONTAINER AND STORAGE AREA FOR THE HAZARDOUS MATERIALS**

Bidders shall submit their bids through their duly authorized representative using the forms specified in the Bidding Documents in **two (2) separate sealed bid envelopes**, and which shall be submitted simultaneously. The first envelope shall contain the technical component of the bid including the eligibility requirements and the second shall contain the financial component of the bid.

I. FIRST ENVELOPE: ELIGIBILITY AND TECHNICAL COMPONENTS:

A. ELIGIBILITY DOCUMENTS:

1. Certified photocopy of the valid and current PhilGEPS Certificate of Registration – Platinum Membership. The certificate shall be submitted together with Annex "A".

If any document mentioned in Annex "A" has expired, the new document should be submitted.

2. Statement of all on-going government and private contracts, including contracts awarded but not yet started, if any, whether similar or not similar in nature and complexity to the contract to be bid (**ANNEX "A"**);

3. Statement of the Single Largest Completed Contract (SLCC) similar to the contract to be bid, entered into within the last three (3) years from the date of submission and opening of bids, and whose value must be at least fifty percent (50%) of the ABC. (**ANNEX "B"**) Attach the following;

- a. Certified photocopy of the SLCC; and
- b. Certificate of Final Acceptance issued by the Owner or the Constructors Performance Evaluation System (CPES) Final Rating, showing at least a "Satisfactory" rating.

4. Net Financial Contracting Capacity (NFCC): (**ANNEX "C"**)

Computation of NFCC must be at least equal to the ABC to be bid, calculated as follows;

$NFCC = [(Current\ assets\ minus\ current\ liabilities) (15)]$ minus the value of all outstanding or uncompleted portions of the projects under ongoing contracts, including awarded contracts yet to be started, coinciding with the contract to be bid.

or a committed Line of Credit from Universal or Commercial Bank, in lieu of its NFCC Computation. The committed Line of Credit must be at least equal to ten percent (10%) of the ABC to be bid.

5. Photocopy of PCAB License, with licensed category of "C & D" in General Engineering/Building.

B. TECHNICAL COMPONENT:

1. Bid Security:

- Notarized Bid Securing Declaration (**ANNEX "D"**); or
 - Cash or Manager's Check / Cashier's check issued by a Universal or Commercial Bank in the amount of not less than 2% of the ABC; or
 - Bank draft/guarantee or irrevocable letter of credit issued by a Universal or Commercial Bank in the amount of not less than 2% of the ABC; or
 - Surety Bond, callable upon demand, issued by a private insurance company with attached Certification issued by the Office of the Insurance Commission that said insurance company is authorized to issue such surety, in the amount of not less than 5% of the ABC.
2. Sections VI – Specifications of the Bidding Documents, fully accomplished;
 3. Notarized Omnibus Sworn Statement (**ANNEX "E"**) with attached;
 - a. For Corporations, the duly notarized Secretary's Certificate; or
 - b. For Sole Proprietorship, the notarized Special Power of Attorney.

II. SECOND ENVELOPE: FINANCIAL COMPONENT OF THE BID (BID PROPOSAL FORMS)

1. Financial Bid Form (Section VIII of the Bidding Documents) with the Bill of Quantities.
-

Note:

To facilitate the evaluation of the bids, bidders are advised to follow the arrangement in the above-mentioned checklist when placed in an Envelope, with documents tabbed and labeled accordingly. See also Annex "F" for guidance.

**SINGLE LARGEST COMPLETED CONTRACT
WHICH IS SIMILAR TO THE CONTRACT TO BE BID**

Business Name:

Business Address:

Name of Contract	a. Owner' Name			Nature of Item/Service	a. Amount of Award			a. Date Awarded		
	b. Address	c. Telephone Nos.			b. Amount at Completion	c. Duration		b. Contract Effectivity	c. Date Completed	

Note: This statement shall be supported with:

1. Contract
2. Certificate of Final Acceptance issued by the owner or the Constructors Performance Evaluation System (CPES)
Final rating showing at least a "Satisfactory" rating.

Note: The Single Largest Completed Contract shall be completed within the last three (3) years from the date of submission and receipt of bids, that is similar to the contract to be bid, the amount of which shall be at least fifty percent (50%) of the ABC.

Submitted by:

(Printed Name & Signature)

Designation:

Date:

--	--	--	--	--	--	--	--	--	--	--

PHILIPPINE INTERNATIONAL CONVENTION CENTER

Name of the Project: **SUPPLY OF LABOR AND MATERIALS FOR THE CONSTRUCTION OF GARBAGE CONTAINER AND STORAGE AREA FOR THE HAZARDOUS MATERIALS**

FINANCIAL DOCUMENTS FOR ELIGIBILITY CHECK

A. Summary of the Applicant Supplier's/Distributor's/Manufacturer's assets and liabilities on the basis of the attached Income Tax Return and Audited Financial Statement, stamped "RECEIVED" by the Bureau of Internal Revenue or BIR authorized collecting agent, for the immediately preceding year and a certified copy of Schedule of Fixed Assets particularly the list of construction equipment.

		Year 20__
1.	Total Assets	
2.	Current Assets	
3.	Total Liabilities	
4.	Current Liabilities	
5.	Net Worth (1-3)	
6.	Net Working Capital (2-4)	
7.	Value of all outstanding or uncompleted portions of the project under ongoing contracts, including awarded contracts yet to be started coinciding with contract to be bid.	

B. The Net Financial Contracting Capacity (NFCC) based on the above data is computed as follows:

NFCC = [(Current assets minus current liabilities) (15)] minus value of all outstanding or uncompleted portions of the project under ongoing contracts, including awarded contracts yet to be started coinciding with contract to be bid.

NFCC = P _____

The values of the bidder's current assets and current liabilities shall be based on the data submitted to the BIR.

or

A committed Line of Credit, in an amount to at least ten percent (10%) of the ABC, issued by a Universal of Commercial Bank.

Submitted by:

Name of Supplier / Distributor / Manufacturer

Signature of Authorized Representative
Date: _____

Note:

1. If Partnership or Joint Venture, each Partner or Member Firm of Joint Venture shall submit the above requirements.

BID SECURING DECLARATION FORM

REPUBLIC OF THE PHILIPPINES)
CITY OF _____) S.S.

x-----x

BID SECURING DECLARATION
Invitation to Bid: [Insert Reference number]

To: *[Insert name and address of the Procuring Entity]*

I/We¹, the undersigned, declare that:

1. I/We understand that, according to your conditions, bids must be supported by a Bid Security, which may be in the form of a Bid-Securing Declaration.
2. I/We accept that: (a) I/we will be automatically disqualified from bidding for any contract with any procuring entity for a period of two (2) years upon receipt of your Blacklisting order; and, (b) I/we will pay the applicable fine provided under Section 6 of the Guidelines on the Use of Bid Securing Declaration, within fifteen (15) days from receipt of the written demand by the procuring entity for the commission of acts resulting to the enforcement of the bid securing declaration under Sections 23.1(b), 34.2, 40.1 and 69.1, except 69.1(f), of the IRR of RA 9184; without prejudice to other legal action the government may undertake.
3. I/We understand that this Bid Securing Declaration shall cease to be valid on the following circumstances:
 - (a) Upon expiration of the bid validity period, or any extension thereof pursuant to your request;
 - (b) I am/we are declared ineligible or post-disqualified upon receipt of your notice to such effect, and (i) I/we failed to timely file a request for reconsideration or (ii) I/we filed a waiver to avail of said right;
 - (c) I am/we are declared the bidder with the Lowest Calculated Responsive Bid, and I/we have furnished the performance security and signed the Contract.

IN WITNESS WHEREOF, I/We have hereunto set my/our hand/s this ____ day of [month] [year] at [place of execution].

¹ Select one and delete the other. Adopt the same instruction for similar terms throughout the document.

*[Insert NAME OF BIDDER'S AUTHORIZED
REPRESENTATIVE]
[Insert Signatory's Legal Capacity]
Affiant*

SUBSCRIBED AND SWORN to before me this ___ day of *[month]* *[year]* at *[place of execution]*, Philippines. Affiant/s is/are personally known to me and was/were identified by me through competent evidence of identity as defined in the 2004 Rules on Notarial Practice (A.M. No. 02-8-13-SC). Affiant/s exhibited to me his/her *[insert type of government identification card used]*, with his/her photograph and signature appearing thereon, with no. _____ and his/her Community Tax Certificate No. _____ issued on ___ at _____.

Witness my hand and seal this ___ day of *[month]* *[year]*.

NAME OF NOTARY PUBLIC

Serial No. of Commission _____

Notary Public for _____ until _____

Roll of Attorneys No. _____

PTR No. _____ *[date issued]*, *[place issued]*

IBP No. _____ *[date issued]*, *[place issued]*

Doc. No. _____

Page No. _____

Book No. _____

Series of _____

Omnibus Sworn Statement

REPUBLIC OF THE PHILIPPINES)
CITY/MUNICIPALITY OF _____) S.S.

AFFIDAVIT

I, *[Name of Affiant]*, of legal age, *[Civil Status]*, *[Nationality]*, and residing at *[Address of Affiant]*, after having been duly sworn in accordance with law, do hereby depose and state that:

1. *Select one, delete the other:*

If a sole proprietorship: I am the sole proprietor or authorized representative of *[Name of Bidder]* with office address at *[address of Bidder]*;

If a partnership, corporation, cooperative, or joint venture: I am the duly authorized and designated representative of *[Name of Bidder]* with office address at *[address of Bidder]*;

2. *Select one, delete the other:*

If a sole proprietorship: As the owner and sole proprietor, or authorized representative of *[Name of Bidder]*, I have full power and authority to do, execute and perform any and all acts necessary to participate, submit the bid, and to sign and execute the ensuing contract for *[Name of the Project]* of the *[Name of the Procuring Entity]*, as shown in the attached duly notarized *Special Power of Attorney*;

If a partnership, corporation, cooperative, or joint venture: I am granted full power and authority to do, execute and perform any and all acts necessary to participate, submit the bid, and to sign and execute the ensuing contract for *[Name of the Project]* of the *[Name of the Procuring Entity]*, as shown in the attached *[state title of attached document showing proof of authorization (e.g., duly notarized Secretary's Certificate, Board/Partnership Resolution, or Special Power of Attorney, whichever is applicable);]*;

- 3.** *[Name of Bidder]* is not "blacklisted" or barred from bidding by the Government of the Philippines or any of its agencies, offices, corporations, or Local Government Units, foreign government/foreign or international financing institution whose blacklisting rules have been recognized by the Government Procurement Policy Board;
- 4.** Each of the documents submitted in satisfaction of the bidding requirements is an authentic copy of the original, complete, and all statements and information provided therein are true and correct;
- 5.** *[Name of Bidder]* is authorizing the Head of the Procuring Entity or its duly authorized representative(s) to verify all the documents submitted;

6. *Select one, delete the rest:*

If a sole proprietorship: The owner or sole proprietor is not related to the Head of the Procuring Entity, members of the Bids and Awards Committee (BAC), the Technical Working Group, and the BAC Secretariat, the head of the Project Management Office or the end-user unit, and the project consultants by consanguinity or affinity up to the third civil degree;

If a partnership or cooperative: None of the officers and members of [Name of Bidder] is related to the Head of the Procuring Entity, members of the Bids and Awards Committee (BAC), the Technical Working Group, and the BAC Secretariat, the head of the Project Management Office or the end-user unit, and the project consultants by consanguinity or affinity up to the third civil degree;

If a corporation or joint venture: None of the officers, directors, and controlling stockholders of [Name of Bidder] is related to the Head of the Procuring Entity, members of the Bids and Awards Committee (BAC), the Technical Working Group, and the BAC Secretariat, the head of the Project Management Office or the end-user unit, and the project consultants by consanguinity or affinity up to the third civil degree;

7. [Name of Bidder] complies with existing labor laws and standards; and

8. [Name of Bidder] is aware of and has undertaken the following responsibilities as a Bidder:

- a) Carefully examine all of the Bidding Documents;
- b) Acknowledge all conditions, local or otherwise, affecting the implementation of the Contract;
- c) Made an estimate of the facilities available and needed for the contract to be bid, if any; and
- d) Inquire or secure Supplemental/Bid Bulletin(s) issued for the [Name of the Project].

9. [Name of Bidder] did not give or pay directly or indirectly, any commission, amount, fee, or any form of consideration, pecuniary or otherwise, to any person or official, personnel or representative of the government in relation to any procurement project or activity.

IN WITNESS WHEREOF, I have hereunto set my hand this __ day of __, 20__ at _____, Philippines.

Bidder's Representative/Authorized Signatory

SUBSCRIBED AND SWORN to before me this ____ day of [month] [year] at [place of execution], Philippines. Affiant/s is/are personally known to me and was/were identified by me through competent evidence of identity as defined in the 2004 Rules on Notarial Practice (A.M. No. 02-8-13-SC). Affiant/s exhibited to me his/her [insert type of government identification card used], with his/her photograph and signature appearing thereon, with no. _____ and his/her Community Tax Certificate No. _____ issued on ____ at _____.

Witness my hand and seal this ____ day of [month] [year].

NAME OF NOTARY PUBLIC

Serial No. of Commission _____

Notary Public for _____ until _____

Roll of Attorneys No. _____

PTR No. _____ [date issued], [place issued]

IBP No. _____ [date issued], [place issued]

Doc. No. _____

Page No. _____

Book No. _____

Series of _____